

MANSFIELD

Produktinformatie



verwerkte materialen

- ROMP** : Verlijmd massiefhouten romp; Meubelplaat; Beaverboard; Multiplex; Karton;
- ZIT** : Nosagveren; Variant 1 - Schuim 35kg/m³ + Zitmat (Schuim+Siliconen);
- ZIT** Variant 2 - Schuim HR 40kg/m³ + Zitmat (Schuim+Siliconen); Diolenwattenafdeklaag;
- RUG** : Schuim 25kg/m³; Diolenwattenafdeklaag;
- POTEN** : Metaal; Hout;

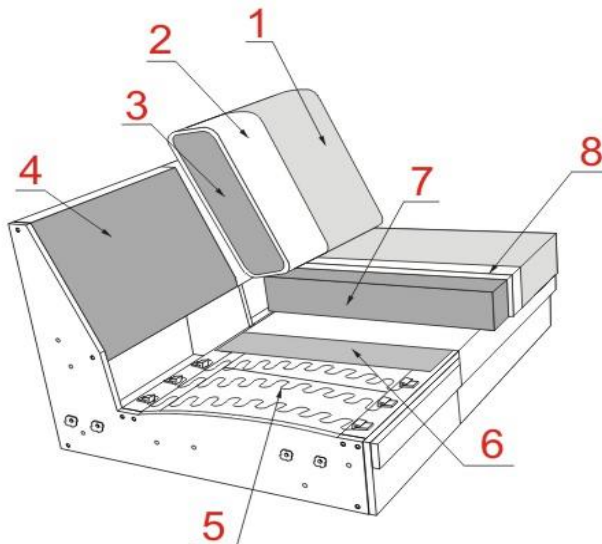

- 1 Stof/Leder
- 2 Diolenwattenafdeklaag
- 3 Schuim 25kg/m³
- 4 Beaverboard
- 5 Nosagveren
- 6 Vezelvlies
- 7 V1-Schuim 35kg/m³; V2-Schuim HR 40kg/m³
- 8 Zitmat (Schuim+Siliconen)

MANSFIELD

Produktinformatie

De elementen kunnen enkel in dezelfde kleur en dezelfde stof of leer gemaakt worden (Uni), afwijkende kleur-, stofcombinaties zijn niet mogelijk. Uitvoeringen in leder hebben andere vlakverdeling/stiknaden dan de uitvoering in stof.

Stoffeerwijze : Vaste stoffering met een nonchalante uitstraling - ploovorming is niet te vermijden c.q. productgebonden.
ZACHT : Zachte nonchalante stoffering waarbij typerende ploovorming / zitafdruk een inherente eigenschap is die bij dit soort stoffering niet te vermijden is.

Belangrijk: de fauteuil (type 1002) heeft een armleuning breedte van ca. 19 cm; alle andere typen hebben een armleuningbreedte van 27 cm.

Twee soorten zitcomfort

- VP/Matte als standaard
- HR/Matte als variant tegen meerprijs

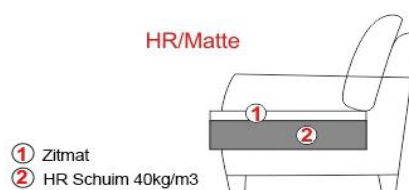
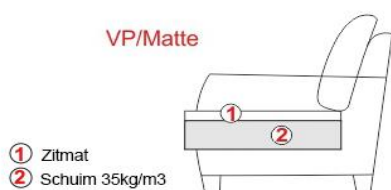

Pootmogelijkheden

- Metalen poten (MF)
- Houten poten (HF)

Twee zithoogtes:

- ZH=46 cm; MF1; HF1; Poothoogte h-13 cm
- ZH=48 cm; MF2; HF2; Poothoogte h-15 cm



MF



HF

Voor beschikbare houtskleuren: zie houtstalen bundel DFM.

Bij dit model zijn de poten niet voorgemonteerd, om transportschade te voorkomen, deze dienen nog gemonteerd te worden.

Zijkant afgestoffeerd

Zijkant kan afgestoffeerd worden tegen meerprijs (zie schets prijslijst)

Bij dit model wordt een haaksysteem gebruikt.







Sierkussens zijn los bij te bestellen.

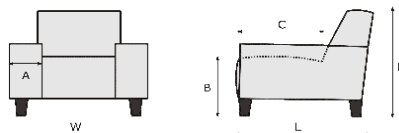





Let op!







De pictogrammen zijn voor verduidelijking en niet exact gelijk aan de werkelijke uitvoering.
Bij de aangegeven maten kunnen afwijkingen ontstaan (+/- 5cm).
Bij het samenstellen van de modellen; noteren van links naar rechts (voorstaand).







A = 27 cm
B = 46 cm; h-13 cm
C = 58 cm
H = 76 cm
L = 96 cm



NL PRIJSLIJST MANSFIELD							
Artikel code		1002 1ALR	2001 2AL	2003 2AR	2002 2ALR	2501 2.5AL	2503 2.5AR
OMSCHRIJVING		Fauteuil	2 zits arm links	2 zits arm rechts	2 zitsbank	2,5 zits arm links	2,5 zits arm rechts
BREEDTE (W)		98 cm	167 cm	167 cm	194 cm	187 cm	187 cm
DIEPTE (L)		96 cm	96 cm	96 cm	96 cm	96 cm	96 cm
HOOGTE (H)		78 cm	76 cm	76 cm	76 cm	76 cm	76 cm
ZITHOOGTE (B) & ZITDIEPTE (C)		46 cm & 58 cm	46 cm & 58 cm	46 cm & 58 cm	46 cm & 58 cm	46 cm & 58 cm	46 cm & 58 cm
QBM		0.66 qbm	1.11 qbm	1.11 qbm	1.29 qbm	1.24 qbm	1.24 qbm
Stof	EUR	EUR	EUR	EUR	EUR	EUR	EUR
2	605	770	770	915	825	825	
3	629	796	796	946	849	849	
4	667	838	838	1.001	895	895	
5	695	873	873	1.043	933	933	
6	715	900	900	1.076	964	964	
7	761	964	964	1.148	1.063	1.063	
8	807	1.027	1.027	1.223	1.135	1.135	
9	869	1.102	1.102	1.311	1.228	1.228	
Leer	EUR	EUR	EUR	EUR	EUR	EUR	EUR
L10 (W1)	1.041	1.302	1.302	1.558	1.384	1.384	
L20 (W2)	1.078	1.349	1.349	1.617	1.430	1.430	
L30 (WM/W9/W12/RETRO)	1.190	1.487	1.487	1.782	1.577	1.577	
L40 (W10/W11/WR)	1.217	1.516	1.516	1.817	1.608	1.608	
L50	1.296	1.608	1.608	1.936	1.709	1.709	
Meerprijs	EUR	EUR	EUR	EUR	EUR	EUR	EUR
HR/MATTE	13	26	26	26	31	31	

NL PRIJSLIJST MANSFIELD							
Artikel code		2502 2.5ALR	3001 3AL	3003 3AR	3002 3ALR	1091 1ABL	1093 1ABR
OMSCHRIJVING		2,5 zitsbank	3 zits arm links	3 zits arm rechts	3 zitsbank	1 zits met eiland links	1 zits met eiland rechts
BREEDTE (W)		214 cm	207 cm	207 cm	234 cm	147 cm	147 cm
DIEPTE (L)		96 cm	96 cm	96 cm	96 cm	96 cm	96 cm
HOOGTE (H)		78 cm	76 cm	76 cm	76 cm	76 cm	76 cm
ZITHOOGTE (B) & ZITDIEPTE (C)		46 cm & 58 cm	46 cm & 58 cm	46 cm & 58 cm	46 cm & 58 cm	46 cm & 58 cm	46 cm & 58 cm
QBM		1.42 qbm	1.37 qbm	1.37 qbm	1.55 qbm	0.98 qbm	0.98 qbm
Stof	EUR	EUR	EUR	EUR	EUR	EUR	EUR
2	968	882	882	1.027	689	689	
3	1.001	913	913	1.063	711	711	
4	1.058	964	964	1.124	744	744	
5	1.102	1.005	1.005	1.175	770	770	
6	1.137	1.034	1.034	1.208	792	792	
7	1.217	1.140	1.140	1.300	803	803	
8	1.296	1.221	1.221	1.384	845	845	
9	1.393	1.313	1.313	1.487	898	898	
Leer	EUR	EUR	EUR	EUR	EUR	EUR	EUR
L10 (W1)	1.641	1.476	1.476	1.729	1.052	1.052	
L20 (W2)	1.701	1.525	1.525	1.793	1.087	1.087	
L30 (WM/W9/W12/RETRO)	1.877	1.676	1.676	1.973	1.177	1.177	
L40 (W10/W11/WR)	1.912	1.712	1.712	2.015	1.199	1.199	
L50	2.039	1.819	1.819	2.147	1.265	1.265	
Meerprijs	EUR	EUR	EUR	EUR	EUR	EUR	EUR
HR/MATTE	31	35	35	35	26	26	

NL PRIJSLIJST MANSFIELD							
Artikel code		6011 E1ABL	6013 E1ABR	6021 LAL	6023 LAR	8030 Sp.Gr	909560 Hocker 95x60
OMSCHRIJVING		Hoeelement + eenzitsbank met eiland links	Hoeelement + eenzitsbank met eiland rechts	Longchair arm links	Longchair arm rechts	Hoeelement groot	Voetenbank 95x60
BREEDTE (W)		93 cm	93 cm	107 cm	107 cm	114 cm	60 cm
DIEPTTE (L)		238 cm	238 cm	168 cm	168 cm	114 cm	95 cm
HOOGTE (H)		78 cm	76 cm	76 cm	76 cm	76 cm	46 cm
ZITHOOGTE (B) & ZITDIEPTTE (C)		46 cm & 58 cm	46 cm & 58 cm	46 cm & 130 cm	46 cm & 130 cm	46 cm & 58 cm	46 cm & 95 cm
QBM		1.57 qbm	1.57 qbm	1.24 qbm	1.24 qbm	0.9 qbm	0.28 qbm
Stof	EUR	EUR	EUR	EUR	EUR	EUR	EUR
2	1.021	1.021	867	867	682	334	
3	1.049	1.049	891	891	706	343	
4	1.100	1.100	933	933	733	354	
5	1.140	1.140	968	968	763	374	
6	1.175	1.175	992	992	781	381	
7	1.254	1.254	1.056	1.056	834	407	
8	1.329	1.329	1.115	1.115	880	429	
9	1.419	1.419	1.184	1.184	939	455	
Leer	EUR	EUR	EUR	EUR	EUR	EUR	
L10 (W1)	1.665	1.665	1.333	1.333	1.087	473	
L20 (W2)	1.723	1.723	1.375	1.375	1.122	488	
L30 (WM/W9/W12/RETRO)	1.883	1.883	1.498	1.498	1.225	528	
L40 (W10/W11/WR)	1.921	1.921	1.525	1.525	1.250	537	
L50	2.031	2.031	1.610	1.610	1.313	565	
Meerprijs	EUR	EUR	EUR	EUR	EUR	EUR	
HR/MATTE	42	42	35	35	22	20	

NL PRIJSLIJST MANSFIELD							
Artikel code		591 2,5AL-E1ABR	590 E1ABL-2,5AR	846 2,5AL-LAR	553 LAL-2,5AR	319 2,5AL-Sp.Gr-1ABR	949 1ABL-Sp.Gr-2,5AR
OMSCHRIJVING		2,5 zits arm links + hoek met eiland rechts	Hoek met eiland links + 2,5 zits arm rechts	2,5 zits arm links + longchair arm rechts	Longchair arm links + 2,5 zits arm rechts	2,5 zits arm links + Hoeelement groot + 1 zits met eiland rechts	1 zits met eiland links + Hoeelement groot + 2,5 zits arm rechts
BREEDTE (W)		279 cm	279 cm	294 cm	294 cm	301 cm	261 cm
DIEPTTE (L)		236 cm	236 cm	168 cm	168 cm	261 cm	301 cm
HOOGTE (H)		78 cm	76 cm	76 cm	76 cm	76 cm	76 cm
ZITHOOGTE (B) & ZITDIEPTTE (C)		46 cm & 58 cm	46 cm & 58 cm	46 cm & 58 cm	46 cm & 58 cm	46 cm & 58 cm	46 cm & 58 cm
QBM		2.81 qbm	2.81 qbm	2.48 qbm	2.48 qbm	3.12 qbm	3.12 qbm
Stof	EUR	EUR	EUR	EUR	EUR	EUR	EUR
2	1.846	1.846	1.692	1.692	2.196	2.196	
3	1.899	1.899	1.740	1.740	2.266	2.266	
4	1.995	1.995	1.828	1.828	2.372	2.372	
5	2.072	2.072	1.901	1.901	2.466	2.466	
6	2.138	2.138	1.956	1.956	2.537	2.537	
7	2.317	2.317	2.119	2.119	2.699	2.699	
8	2.464	2.464	2.251	2.251	2.860	2.860	
9	2.647	2.647	2.411	2.411	3.065	3.065	
Leer	EUR	EUR	EUR	EUR	EUR	EUR	
L10 (W1)	3.049	3.049	2.717	2.717	3.522	3.522	
L20 (W2)	3.153	3.153	2.805	2.805	3.639	3.639	
L30 (WM/W9/W12/RETRO)	3.461	3.461	3.076	3.076	3.980	3.980	
L40 (W10/W11/WR)	3.529	3.529	3.133	3.133	4.057	4.057	
L50	3.740	3.740	3.320	3.320	4.288	4.288	
Meerprijs	EUR	EUR	EUR	EUR	EUR	EUR	
HR/MATTE	73	73	66	66	79	79	

NL PRIJSLIJST MANSFIELD				
Artikel code	4566 2AL-Sp.Gr-2,5AR	4567 2,5AL-Sp.Gr-2AR	9191 Seite echt bezogen links	9193 Seite echt bezogen rechts
OMSCHRIJVING	2 zits arm links + Hoekelement groot + 2,5 zits arm rechts	2,5 zits arm links + Hoekelement groot + 2 zits arm rechts	Zijkant doorgestoffeerd links	Zijkant doorgestoffeerd rechts
BREEDTE (W)	281 cm	301 cm	1 cm	1 cm
DIEPTE (L)	301 cm	281 cm	cm	cm
HOOGTE (H)	76 cm	76 cm	cm	cm
ZITHOOGTE (B) & ZITDIEPTE (C)	46 cm & 58 cm	46 cm & 58 cm	cm & cm	cm & cm
QBM	3.25 qbm	3.25 qbm	0 qbm	0 qbm
Stof	EUR	EUR	EUR	EUR
2	2.277	2.277	119	119
3	2.352	2.352	119	119
4	2.466	2.466	119	119
5	2.570	2.570	119	119
6	2.644	2.644	119	119
7	2.860	2.860	119	119
8	3.043	3.043	119	119
9	3.269	3.269	119	119
Leer	EUR	EUR	EUR	EUR
L10 (W1)	3.773	3.773	178	178
L20 (W2)	3.901	3.901	178	178
L30 (WM/W9/W12/RETRO)	4.290	4.290	178	178
L40 (W10/W11/WR)	4.374	4.374	178	178
L50	4.631	4.631	178	178
Meerprijs	EUR	EUR	EUR	EUR
HR/MATTE	79	79		